



Simulation of the Production Process Dynamics using Vensim and Stella

Corina SBUGHEA*

ARTICLE INFO

Article history:

Accepted February 2016

Available online April 2016

JEL Classification

D2, L6, C8

Keywords:

Simulation, Production, Industrial dynamics, Level, Rate, Flow

ABSTRACT

This paper aims to make a brief presentation of the principles of dynamic systems and to analyze two applications support for modeling and simulation of the evolution of these systems. For illustration, we chose a classic model of the dynamics of the production process, which we have implemented in Vensim and Stella, in order to obtain evolutionary trajectories of the endogenous variables and analyze the behavior of the system.

© 2016 EAI. All rights reserved.

1. Introduction

The surrounding reality is actually made up of smaller or large, complex or less complex systems, which interacts with each other, exchanging information, matter or energy. Therefore it is no wonder that scientists have made efforts over time to shape the sciences that are based on the concept of system. Although it can be said that such approaches have emerged since antiquity, general systems theory appeared only after the World War II (Oprescu, Spircu, Zaharia, 1997).

There have been enunciated many definitions of the concept of the system, both in engineering disciplines and in social approaches. Further we recall the definition from the explanatory dictionary of the Romanian Language: *assembly of elements (principles, rules, forces etc.) dependent on each other and forming an organized whole, which put order in a field of theoretical thinking, regulates the classification of material in a field of natural sciences, or makes a practical activity to operate according to the aim pursued.*

It follows that a system has certain characteristic properties, which are not necessarily valid for its components taken separately, so these can not be analyzed at the level of each element or subsystem.

The system and its properties, were the object of study for many relatively new sciences and disciplines such as Cybernetics, Operational Research, Systems Dynamics, System Analysis, and so on.

Systems Dynamics as a science, it is considered that was born with the publication of J.W. Forrester work, "Industrial Dynamics" in 1958. This was followed by numerous developments and formalization of the concepts, retrieved in various fields of human activity. Along with the innovations in information technology and the development of performant computers, the study of systems behavior, whatever their nature, has become more accessible. Modern information technology offers significant benefits to all categories of users, especially to decision-makers, generating competitive advantages (Lupasc A., Lupasc I.& Zamfir C., 2011).

2. Theoretical framework

First we will give a brief overview of the principles and concepts, which were the basis for development of system dynamics. In the fundamental principles of Industrial Dynamics, Jay W. Forrester, places as a central element, the concept of the system, as follows (Sandor, 2003): any system is made up of interdependent components that work together to achieve a goal; system structure is defined by the multitude of connections between components that form the whole; the complexity of the whole depends more on its structure than on the nature of its components; two systems with partial identical structures (homeomorphic) will have a similar behavior (principle used in simulation); static structure of a system pre-exist the system dynamics; the movements in a system are achieved through concrete and continuous flows (the fluxes from an economic organism are grouped in material flows, commands flows, money flows, human flows, equipment flows and information flows, the latter being considered the most important); decision-making processes are presumed to be discontinuous; the development and perpetuation of the systems, are achieved through regulatory mechanisms; the processes in economic systems are usually nonlinear.

* Dunarea de Jos University of Galati, Romania. E-mail address: sbughea@yahoo.com (Sbughea C.).

The basic structure of a model, according to the theory of industrial dynamics must contain the following types of components: level variables, flows of various kinds established between levels, decision functions which set flow rates between levels and information channels linking the decision functions to the level variables (Forrester, 1961).

By level variables, Forrester defines the accumulations in the system which are formed from the difference between incoming flows and the outputs. The rates of flows describe the activity, as it is determined by the decision functions, and these in turn, are described by rate equations. Information about the levels are the only one that influence decision functions, as rates can not be the inputs for other rates.

To describe the system behavior, Forrester proposes the dividing of time scale into intervals, which are noted with $DT = \text{delta time}$. There may be three points in time at which to describe a certain level, the present moment (K), the previous moment (J) and the future moment(L), JK and KL intervals being equal.

The model's equations are mainly of two kinds: level equations, which are always the first to be evaluated, and the rate equations, which are using the results from level equations. In some cases there may be another type, namely auxiliary equations, that must be calculated between the level and rate. The latter are fed into the model, usually to reduce the complexity of rate equations and to separate the influence of different factors on decisions.

Sometimes initial values of levels should be evaluated on the basis of constants, and this is accomplished by initial-value equations that are calculated only once, at first, for each model run. Model representation can be made both by equations and diagrams, the author of industrial dynamics theory proposing that this should be done at the same time. The symbols used are rectangles for level variables and valves for rates, as can be seen in Figure 2.1.

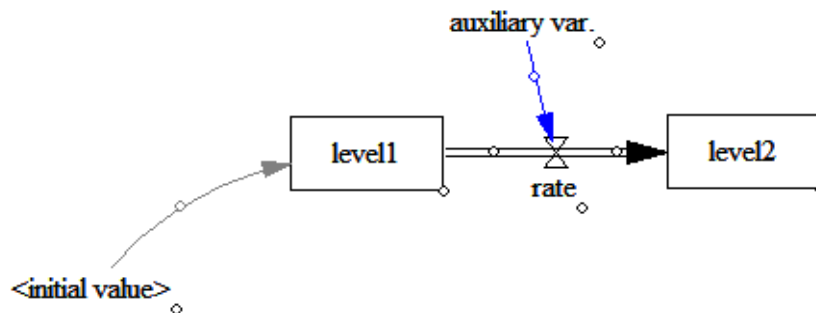

Fig.2.1. Symbols in flow diagrams

Flow charts are useful for the visualization of the rate and level variables influences, creating an overview of the model, but quantitative expression of these influences can only be done by describing the equations.

2.1. Using Vensim and Stella for the implementation of the model

We have chosen for illustration, a model of a firm which is developing a production process, adapted from Forrester production-distribution model, as shown in Oprescu, Spiricu, Zaharia (1997). Thus the analyzed process is characterized by two level variables, the ordered merchandise (MC) and the stock of merchandise (ST).

The rate variables of the model are: the rhythm of ordering (RC), which is an input variable for the ordered merchandise level, the rate of production (RP), which is an input flow to stock and an output flow to ordered merchandise variable and the deliveries rate (RL), which is an output flow for the stock variable.

In the model intervene a series of auxiliary variables: time for adjusting the level of orders in manufacturing (TA), which influences the production rate variable, the required stock (SD), the difference to be stocked (DA), which will be determined by the difference between the required stock and the current level of stock, and the delay in manufacturing (IF), that will influence the rate of production.

In the denomination of variables, we kept authors notations, coming from Romanian. The equations of the model presented in Oprescu, Spiricu and Zaharia (1997), follow the rules and principles of industrial dynamics:

$$MC.K = MC.J + DT * (RC.JK - RP.JK)$$

$$ST.K = ST.J + DT * (RP.JK - RL.JK)$$

$$DA.K = SD - ST.K$$

$$RC.KL = DA.K / TA$$









$$RP.KL = MC.K / IF$$

where DT is the size of the time interval, K = the current moment of time, J = the previous moment, and L = the future moment of time.

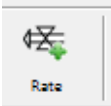
We intend to implement the above model, using two software, Vensim and Stella, which provide tools for description and simulation, in order to study the system behavior.

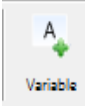
First we will make a brief presentation of the tools provided by the two software chosen. Thus, both programs have a friendly interface, providing the user specific buttons for entering all kinds of variables that may arise into a model of industrial dynamics. Vensim uses Rate and Box variables and Stella, Stock and Uniflow/Biflow variables, as seen in the table below:

Table 2.1. Structural elements for building diagrams

Element \ Representation	Vensim	Stella
Level	 Box Variable	 Stock
Rate	 Rate	 Uniflow/Biflow
Auxiliary variable	 Variable	 Converter
Influence	 Arrow	 Action Connector

Respecting the principles of industrial dynamics, we can trace the flow diagram for the model described above, using the tools provided by the two utility programs, as follows:

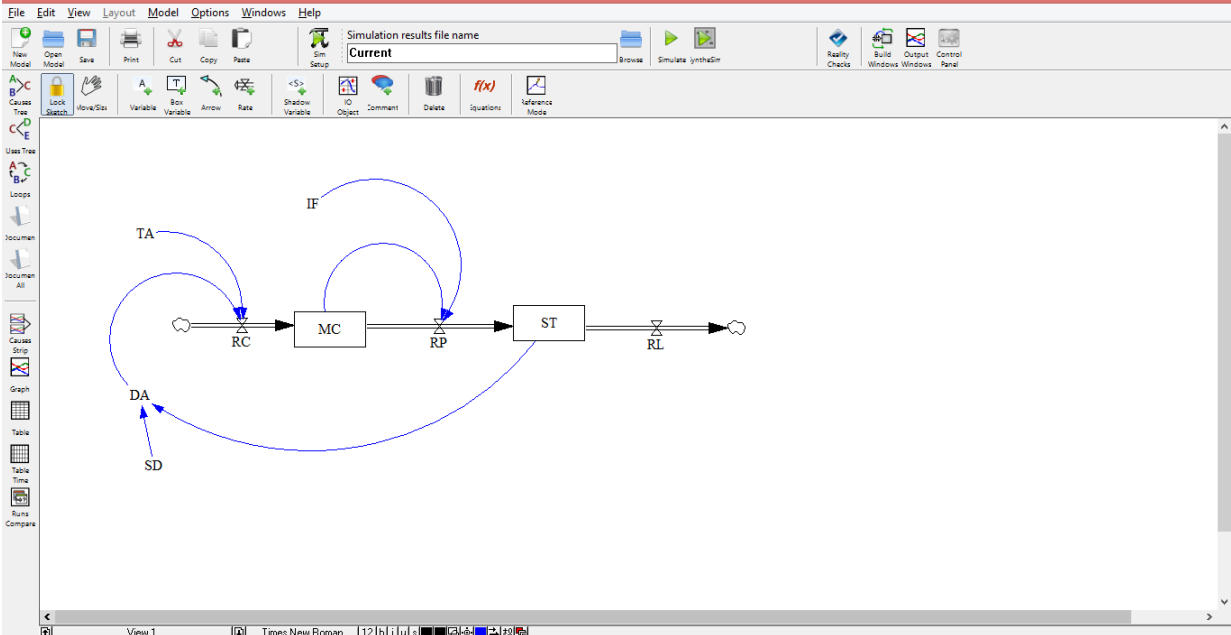

Fig.2.2. The flow diagram in Vensim

After establishing all the functional dependencies between variables, in order to run the simulations, it is necessary to introduce the equations of the model.

In Vensim editing the equation of a variable from the flow diagram, is accomplished using the button Equations, which opens a dialog box for each selected component, in order to establish the mathematical expressions, measurement units, initial values or some explanatory comments.

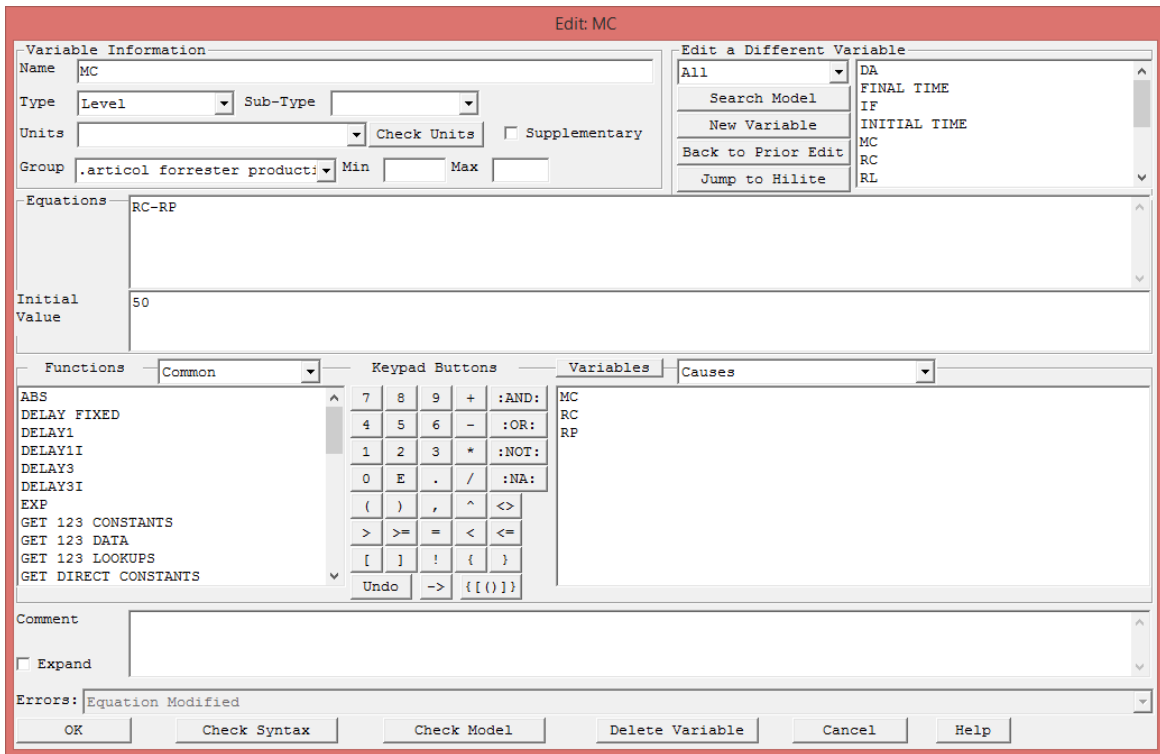

Fig.2.3. Editing the equations in Vensim

As regards the second software, Stella, the influences diagram of the system can be drawn in the Map Layer (window).

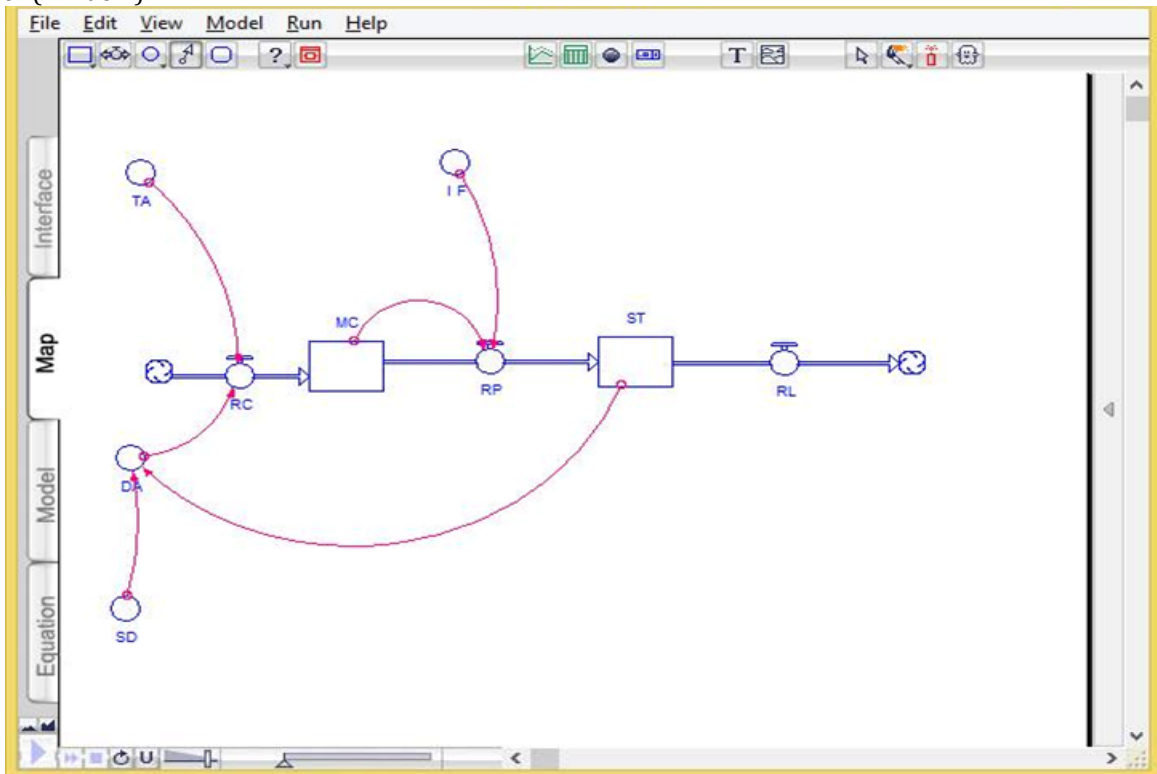

Fig.2.4. Influences Diagram in Stella

Equational description of the dependencies between variables can be done in Layer Model, by displaying Equation Panel. Also here are inserted the initial values, units of measure, or other options that determine the evolution of the selected variable.

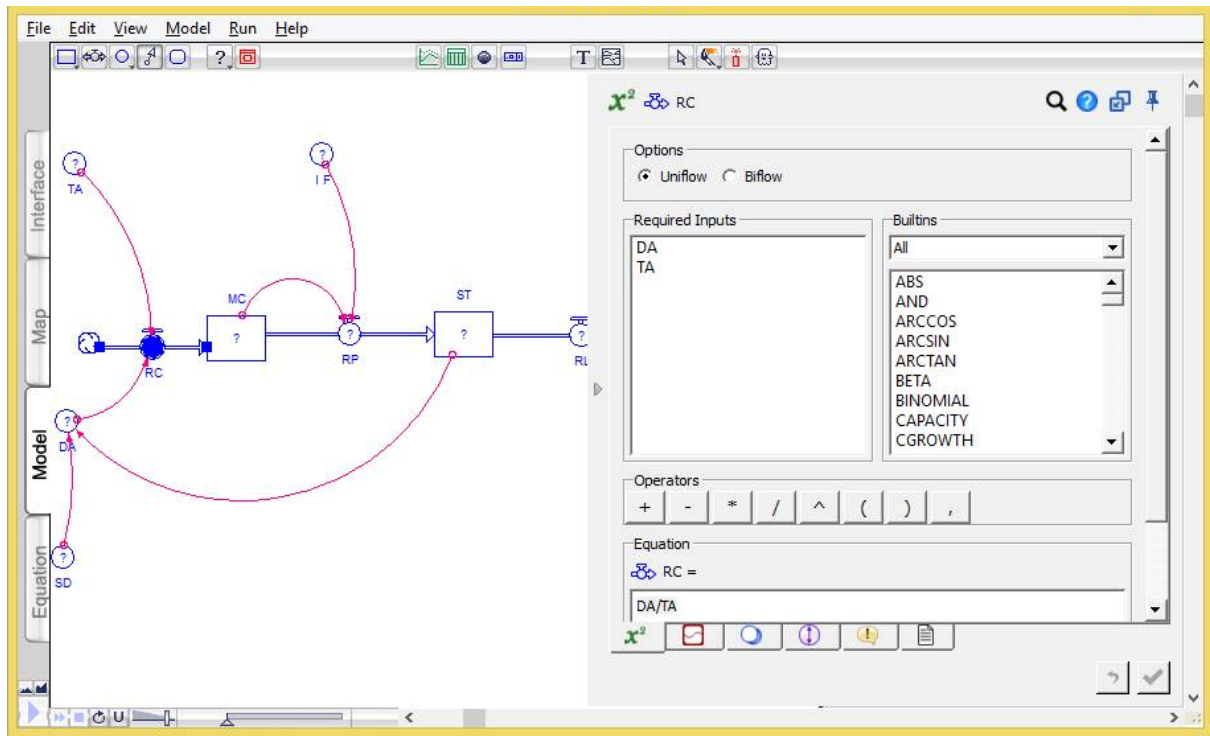

Fig.2.5. Equation Panel in Stella

2.2. Plotting the trajectories in Vensim and Stella

Once the model is completely described by the equation, and have established the initial values of variables, we can simulate the evolution of the system over time. This can be achieved in Vensim, using either Simulate button on the toolbar or the Simulate option from the Model menu.

Evolutionary trajectories of the system for the next set of inputs: $SD = 500$ units, $TA = 2$ weeks, $MC = 200$ units, $IF = 1$ week, $ST = 600$ units, $RL = 20$ units / week, can be seen in Figure 2.6. Vensim displays a chart of an endogenous variable, along with the evolutionary trajectories of its causal variables, by using the Causes Strip button. For the data set considered, the system will evolve with constant amplitude oscillations, therefore will not stabilize in time.

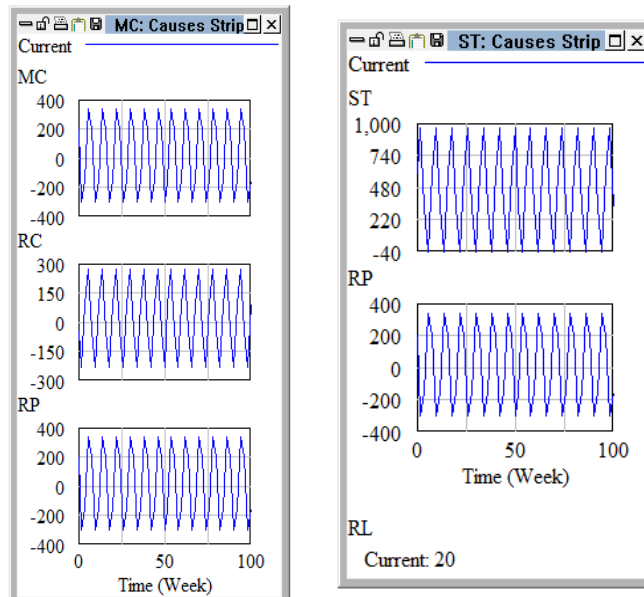

Fig.2.6. Trajectories with constant oscillations (Vensim)

In Figure 2.7. were plotted the trajectories of the system, which resulted from running the simulation for the second set of input data: $SD = 300$ units, $TA = 3$ weeks, initial $MC = 150$ units, $IF = 2$ weeks, initial $ST = 500$ units, $RL = 10$ units / week. In this case, the system will have an oscillatory convergent trajectory, therefore will stabilize over time.

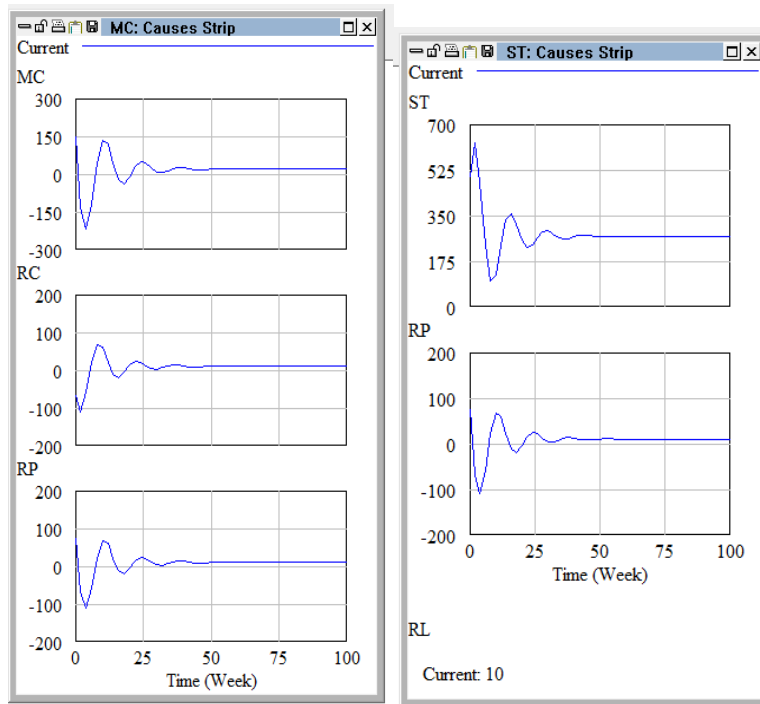

Fig.2.7. Oscillatory convergent trajectories (Vensim)

To perform simulations in Stella, we can use the Run option from the Run menu, after previously establishing: the initial moment, the final moment and the time units, in the Run Specs dialog window. Figure 2.8. illustrates the oscillatory evolution with constant amplitude, which the system follows when the simulation is done with the first set of data (the same ones that were used in Vensim).

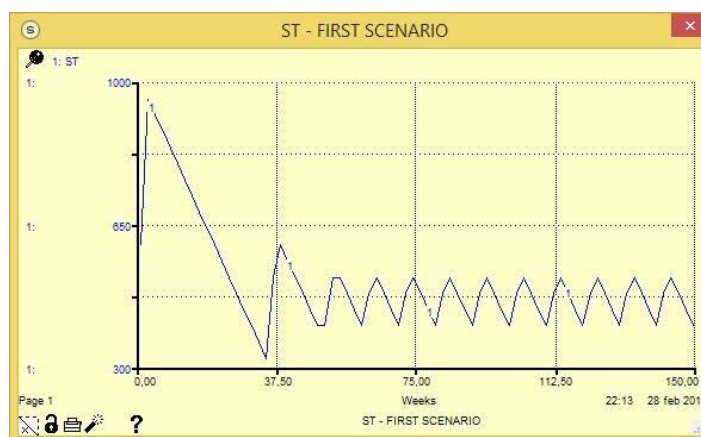
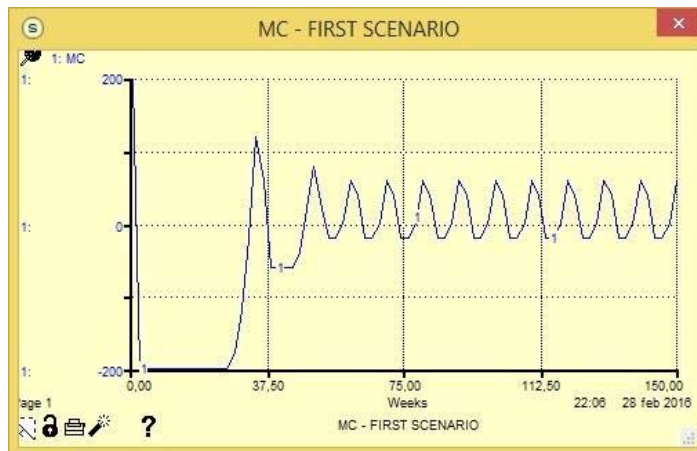

Fig.2.8. Trajectories with constant oscillations in time (Stella)

Similarly can be achieved the oscillatory convergent behavior of the system, in the case of the second set of data (the same that was used in Vensim).

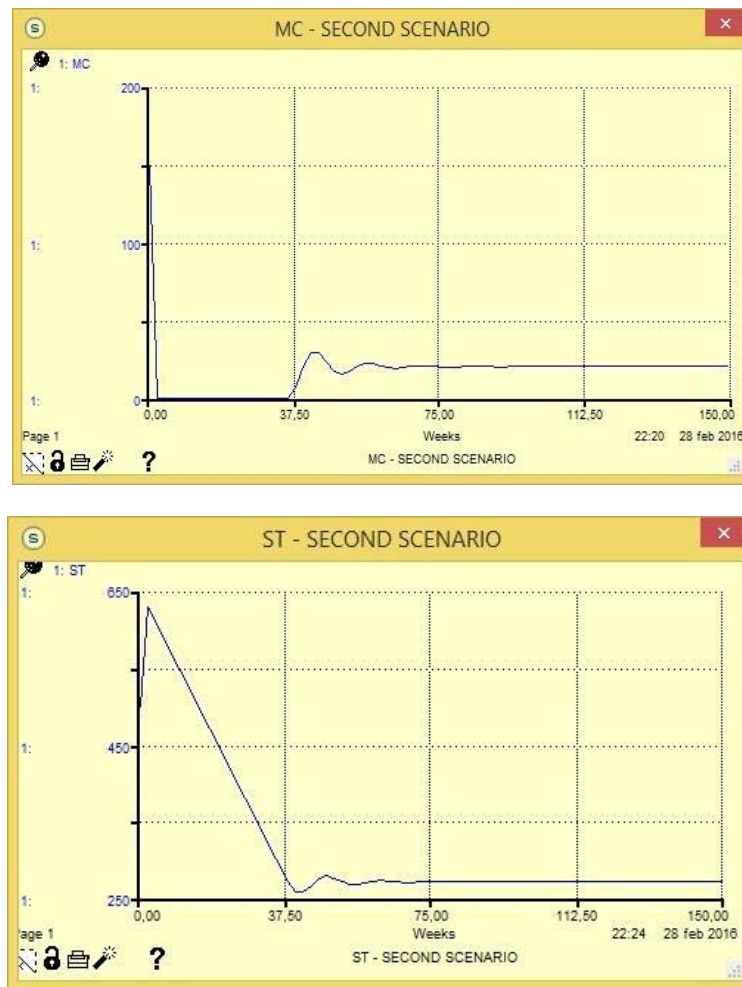

Fig.2.9. Oscillatory convergent trajectories (Stella)

5. Conclusions

Both Vensim and Stella are applications that have user-friendly interface, which provide support for modeling and testing dynamic systems, whatever their nature. Starting with a classic model from system dynamics theory, choosing appropriate inputs, we could trace two kinds of evolution trajectories for the system, using the tools provided by both applications.

The user who wishes to implement and analyze a particular system, should not have programming skills, because it is not necessary to write code.

Both programs include buttons for representing the components of diagrams, using drag-and-drop technique, and dialog windows with editing boxes, for equations writing, initialization of variables and for setting measurement units.

After running the simulation, results can be displayed using graphs that illustrate the trajectories of evolution over time of the variables, or can be viewed in the form of time series. In conclusion, both utility programs provide conclusive results with minimal effort, as long as the real system is correctly described using interdependencies between level and rate variables.

Choosing one over the another is purely arbitrary. According to Lupasc A., Lupasc I. & Zamfir C. (2012), increasing the quality of decisions can only be achieved through a multidisciplinary approach, currently being essential to use software tools.

References

1. Oprescu G., Spircu L., Zaharia M. (1997), *Bazele Ciberneticii Economice*, Ed. Inforec, București
2. Forrester J.W. (1961). "Industrial Dynamics". The M.I.T. Press
3. Scarlat E., Zaharia M., Piculescu V., (1995), *Dinamica Sistemelor. Probleme si studii de caz*, Ed. A.S.E., București
4. Scarlat E., Chiriță N. (1997), *Bazele Ciberneticii Economice*, Ed. Economică, București
5. Spircu L., Scarlat E., Oprescu G. (2002), *Bazele Ciberneticii Economice. Modelarea și reglarea optimă a sistemelor cibernetico-economice*, Ed. ASE, București
6. Stancu S. (2003), *Modelarea Cibernetică a Fenomenelor Economice*, Ed. ASE, București

7. Stancu S., Marinescu D., Maican F., Georgescu I. (2001), *Cibernetică Economică*, Ed. ASE, București
 8. Sandor S.D., 2003, *DYNAMIC SYSTEMS MODELING*, Revista Transilvană de Științe Administrative, Nr.1
 9. Lupasc A.& Lupasc I. & Zamfir C., 2012. "Impact of Intelligent Modern Technologies in Business," *Ovidius University Annals, Economic Sciences Series, Ovidius University of Constantza, Faculty of Economic Sciences, vol. 0(1), pages 580-585, May.*
 10. Lupasc A.& Lupasc I. & Zamfir C., 2011. "Integration of Modern Information Technologies in the Field of Financial Accounting," *Risk in Contemporary Economy, "Dunarea de Jos" University of Galati, Faculty of Economics and Business Administration, pages 184-189.*
- *** <http://vensim.com/support/>
- *** http://www.iseesystems.com/community/downloads/tutorials/stella_sample_lessons.aspx